



● JC532

1.MATERIAL

- 1-1 CONTACT PIN: COPPER ALLOY
- 1-2 SOLDER PAD: COPPER ALLOY
- 1-3 SPRING: SWP-B.PIANO WIRE OR EQUIVALENT
- 1-4 HOUSING: HIGH-TEMPRESIN RATED, UL-94V-0.BLACK

2.MECHERCAL SPECIFICATION:

- 2-1 CONTACTFORCE(PER CONTACT): 90±25gf AT 0.70mm WORKING HEIGHT
- 2-2 MAXMUM FULL STROKE: 1.0mm WORKING HEIGHT: 0.7 mm
- 2-3 DURABILITY: 10,000 CYCLES

3.ELECTRICAL SPECIFICATION:

- 3-1 RATED VOLTAGE(PER CONTACT): 12 VOLTS MAX.
- 3-2 RATED CURRENT(PER CONTACT): 2 AMPS MAX.
- 3-3 CONTACT RESISTANCE: 30 MILLIOHMS MAX.

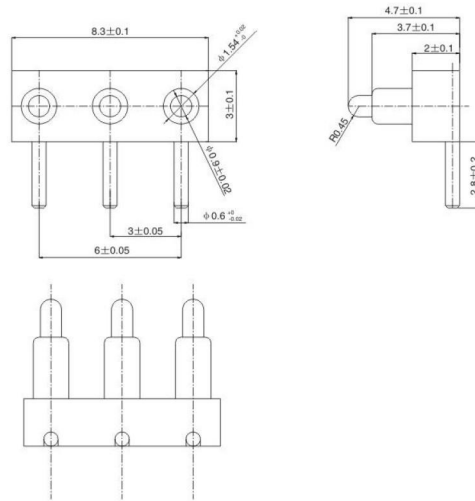

● JC667

1.MATERIAL

- 1-1 CONTACT PIN: COPPER ALLOY
- 1-2 SOLDER PAD: COPPER ALLOY
- 1-3 SPRING: SWP-B.PIANO WIRE OR EQUIVALENT
- 1-4 HOUSING: HIGH-TEMPRESIN RATED, UL-94V-0.BLACK

2.MECHERCAL SPECIFICATION:

- 2-1 CONTACTFORCE(PER CONTACT): 60±25gf AT 0.5mm WORKING HEIGHT
- 2-2 MAXMUM FULL STROKE: 1.2mm WORKING HEIGHT: 0.5mm
- 2-3 DURABILITY: 10,000 CYCLES

3.ELECTRICAL SPECIFICATION:

- 3-1 RATED VOLTAGE(PER CONTACT): 12 VOLTS MAX.
- 3-2 RATED CURRENT(PER CONTACT): 2 AMPS MAX.
- 3-3 CONTACT RESISTANCE: 30 MILLIOHMS MAX.

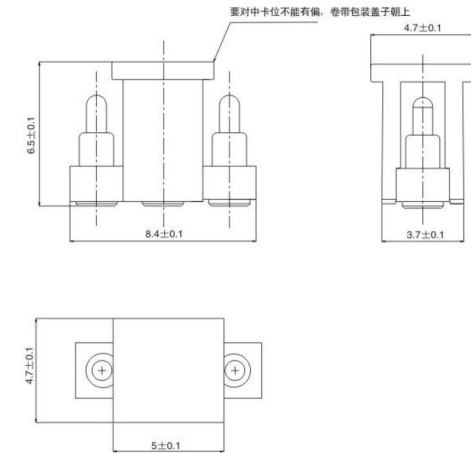

● JC641

1.MATERIAL

- 1-1 CONTACT PIN: COPPER ALLOY
- 1-2 SOLDER PAD: COPPER ALLOY
- 1-3 SPRING: SWP-B.PIANO WIRE OR EQUIVALENT
- 1-4 HOUSING: HIGH-TEMPRESIN RATED, UL-94V-0.BLACK

2.MECHERCAL SPECIFICATION:

- 2-1 CONTACTFORCE(PER CONTACT): 130±25gf AT 1.2mm WORKING HEIGHT
- 2-2 MAXMUM FULL STROKE: 2.0mm WORKING HEIGHT: 1.2mm
- 2-3 DURABILITY: 10,000 CYCLES

3.ELECTRICAL SPECIFICATION:

- 3-1 RATED VOLTAGE(PER CONTACT): 12 VOLTS MAX.
- 3-2 RATED CURRENT(PER CONTACT): 2 AMPS MAX.
- 3-3 CONTACT RESISTANCE: 30 MILLIOHMS MAX.

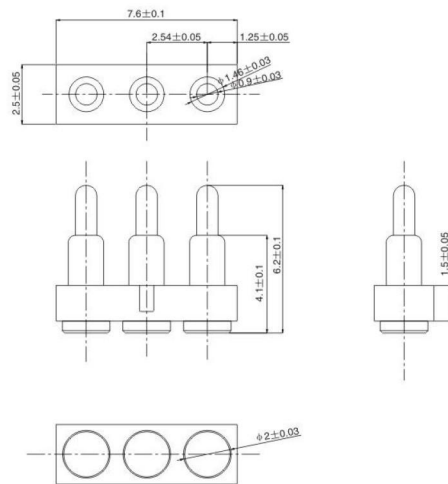

● JC779

1.MATERIAL

- 1-1 CONTACT PIN: COPPER ALLOY
- 1-2 SOLDER PAD: COPPER ALLOY
- 1-3 SPRING: SWP-B.PIANO WIRE OR EQUIVALENT
- 1-4 HOUSING: HIGH-TEMPRESIN RATED, UL-94V-0.BLACK

2.MECHERCAL SPECIFICATION:

- 2-1 CONTACTFORCE(PER CONTACT): 100±25gf AT 1.0mm WORKING HEIGHT
- 2-2 MAXMUM FULL STROKE: 1.3mm WORKING HEIGHT: 1.0mm
- 2-3 DURABILITY: 10,000 CYCLES

3.ELECTRICAL SPECIFICATION:

- 3-1 RATED VOLTAGE(PER CONTACT): 12 VOLTS MAX.
- 3-2 RATED CURRENT(PER CONTACT): 2 AMPS MAX.
- 3-3 CONTACT RESISTANCE: 30 MILLIOHMS MAX.

