

- NOTES:
- MECHANICAL: MATING FORCE: 5-20N .
UNMATING FORCE: 8-20N .
DURABILITY: 10000 CYCLES MIN.
 - ELECTRICAL:
CURRENT: 5.0A MAX
VOLTAGE: 20V MAX
WITHSTANDING VOLTAGE: 100V AC
CONTACT RESISTANCE: 40 mΩ MAX INITIAL;
50 mΩ MAX AFTER 10000 CYCLES
 - ENVIRONMENTAL:
OPERATING TEMPERATURE RANGE -30°C ~ +80°C
 - Salt Spray: 24H

A1	GND	B12	GND
A2		B11	
A3		B10	
A4	VBUS	B9	VBUS
A5	CC1	B8	SBU2
A6	D+	B7	D-
A7	D-	B6	D+
A8	SBU1	B5	CC2
A9	VBUS	B4	VBUS
A10		B3	
A11		B2	
A12	GND	B1	GND

BOM			
序号	名称	用量	品名规格
1	外壳	1	Typec 16PIN 沉板 0.8 外壳 SUS304 T=0.30mm
2	Molding 3	1	Typec 16PIN 沉板 0.8 Molding C7025 T=0.15 PA9T黑色 半成品
2.1	Molding 1	1	Typec 16PIN 沉板 0.8 Molding A C7025 PA9T黑色
2.2	Molding 2	1	Typec 16PIN 沉板 0.8 Molding B C7025 PA9T黑色
2.3	卡勾	1	Typec 16PIN 沉板 卡勾 SUS301 T=0.15mm

振端精密科技 (深圳) 有限公司
Zhenduan precision technology (Shenzhen) Co., Ltd

TOLERANCE: X.XX ±0.30 X.XXX ±0.20 X.XXX ±0.10 X.X ±0.10 X.X ±0.05	DRAWN BY : 刘志强	DATE : 2015.08.18	PART NAME: Type-C 16PIN 沉板0.8 L=6.5mm
UNIT: mm [inch] SCALE: 1:1 SIZE: A4	CHECKED BY: 李毅	DATE : 2015.08.18	PART NO. SEE TABLE MOLD NO.
	APPROVED BY: 张少辉	DATE : 2015.08.18	DRAW NO: ZDJNKJ00001619 SHEET NO. 1 OF 1

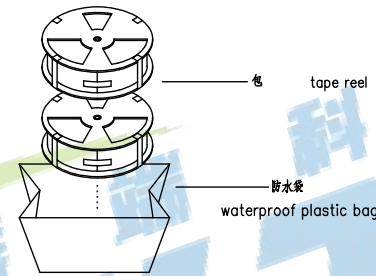
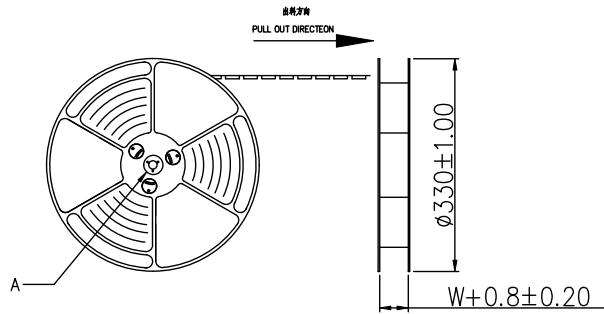

at small positioning hole of the carrier tape side.
 在（朝 包材的小定位孔一）

Location of label sticking (label)

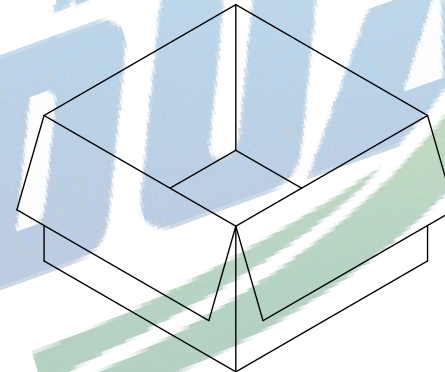
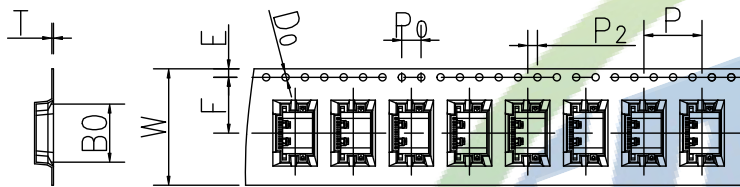
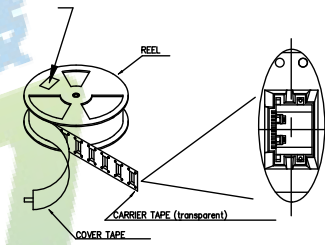

箱: 340mmX340mmX325mm

NOTE:

1. 每包量及每箱量如左下表格。
Packing q'ty of each reel & carton as below table shown.
2. 产品的卷放入箱并以封口。
Put reels in the carton and use adhesive tape to seal up.

NOTES

1. 牙明度
LEAD TAPE LENGTH
量数列
PULL OUT DIRECTION

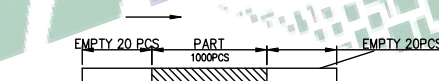

2. 上 剥力: 0.1~1.3N(10.2gf~130gf)
PEELING OFF FORCE OF TOP TAPE: 0.1~1.3N(10.2gf~130gf)
注: 图中一定注意:
THIS REQUIREMENT SHOULD BE APPLIED AT SHIPMENT:
每卷 卷中不覆量
PEELING OFF SHOULD NOT BE ALLOWED DURING TRANSPORTATION

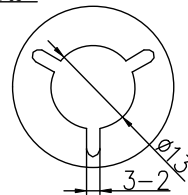
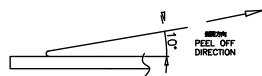

DETAIL: A
10:1

W	24.00±0.3
A0	7.6±0.1
B0	12.0±0.1
K0	3.55±0.1
P	12.00±0.1
F	11.50±0.1
E	1.75±0.1
D0	1.50±0.1
P0	4.00±0.1
P2	2.00±0.1
T	0.35±0.1

卷带	规格: $\phi 330\text{mm}$	包装数量: 10000PCS
纸箱	规格: 340mmX340mmX325mm	包装数量: 10盘(10000PCS)

振端精密科技 (深圳) 有限公司
 Zhenduan precision technology (Shenzhen) Co., Ltd

TOLERANCE: X.XX ±0.30 X.XXX ±0.20 X.XXX ±0.10 X.X ±10° X.X ±5°	DRAWN BY : 刘志强	DATE : 2015.08.18	PART NAME: Type-C 16PIN 流板0.8 L=6.5mm
UNIT: mm [inch] SCALE: 1:1 SIZE: A4	CHECKED BY: 李毅	DATE : 2015.08.18	PART NO. SEE TABLE MOLD NO.
	APPROVED BY: 张少辉	DATE : 2015.08.18	DRAW NO: ZDJNKJ00001619 SHEET NO. 1 OF 1