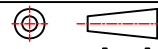

NOTE:

1. MATERIAL SPECIFICATION:
 1. HOUSING: HIGH TEMPERATURE RESISTANT PLASTIC, UL94 V-0.
 2. CONTACTS: COPPER ALLOY
 3. MID PLATE: STAINLESS STEEL
 4. INSIDE SHELL: STAINLESS STEEL
 5. OUTSIDE SHELL: STAINLESS STEEL
2. PLATING SPECIFICATION:
 - 2-1. CONTACTS:
 - Ni 50u" MIN. UNDER PLATED OVER ALL.
 - Au PLATED ON THE FUNCTIONAL AREA OF CONTACT.
 - (GOLD PLATING THICKNESS FOLLOW THE P/N)
 - GOLD FLASH PLATING ON SOLDER AREA
 - 2-2. INSIDE SHELL OR OUTSIDE SHELL:
 - Ni 30u" MIN. UNDER PLATED OVER ALL.
3. MECHANICAL PERFORMANCE,
 - 3-1. INSERTION FORCE: 0.5~2.0kgf.
 - 3-2. REMOVAL FORCE: 0.8kgf~2.0kgf.
 - 3-3. DURABILITY: 10000 CYCLES.
4. ELECTRICAL PERFORMANCE,
 - 4-1. CURRENT RATING: 5A
 - VOLTAGE RATING: 20V
 - 4-2. INSULATION RESISTANCE: 100MΩ MIN
 - 4-3. DIELECTRIC WITHSTAND VOLTAGE, AC 100V FOR 1 MINUTE.
 - 4-4. LOW CONTACT RESISTANCE: INITIAL 40MΩ
 - AFTER 50MΩ
5. ENVIRONMENTAL PERFORMANCE:
 - OPERATING TEMPERATURE: -30°C~+80°C.
6. IR REFLOW:
 - THE PEAK TEMPERATURE ON THE BOARD SHALL BE MAINTAINED FOR 10 SECONDS AT 260°C.

 振端精密科技 (深圳) 有限公司 Zhenduan precision technology (Shenzhen) Co., Ltd			
TOLERANCE: X.X ±0.30 X.XX ±0.20 X.XXX ±0.10 X.XX ±0.10 X.X ±0.05 X.X ±0.05	DRAWN BY : 刘志强	DATE : 2015.08.18	PART NAME: TYPE-C16P四脚插板加高4.3-5.9
 UNIT: mm [inch] SCALE: 1:1 SIZE: A4	CHECKED BY: 李文毅	DATE : 2015.08.18	PART NO. SEE TABLE MOLD NO.
	APPROVED BY: 张少辉	DATE : 2015.08.18	DRAW NO: ZDJNKJ00001627 SHEET NO. 1 OF 1

7.P/N: UC804-0161X-001R

16:16 PIN

B:Black
N:NATURE

K: GOLD FLASH PLATING ON CONTACT AREA,
GOLD FLASH PLATING ON SOLDER AREA
L: 3u" GOLD PLATING ON CONTACT AREA,
GOLD FLASH PLATING ON SOLDER AREA

USB TYPE-C PIN ASSIGNMENTS

PIN NUMBER	SIGNAL NAME	PIN NUMBER	SIGNAL NAME
A1	GND	B12	GND
A4	VBUS	B9	VBUS
A5	CC1	B8	SBU2
A6	Dp1	B7	Dn2
A7	Dn1	B6	Dp2
A8	SBU1	B5	CC2
A9	VBUS	B4	VBUS
A12	GND	B1	GND

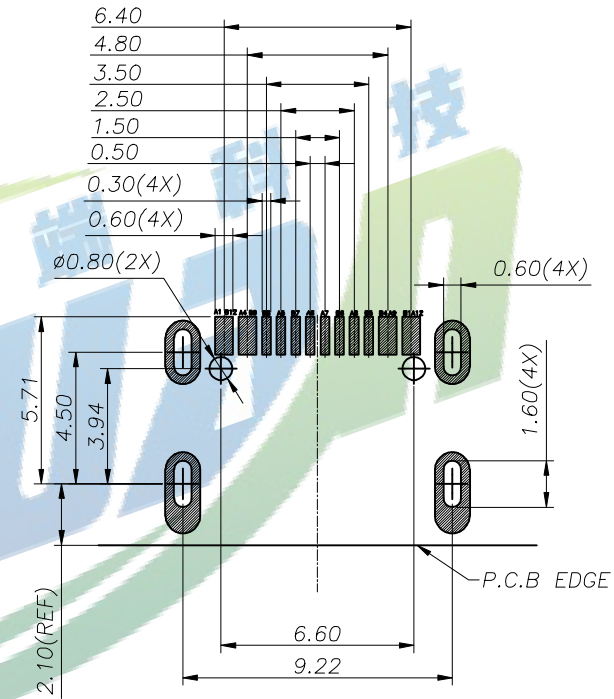

RECOMMEND P.C.B LAYOUT (COMPONENT SIDE)
TOLERANCE FOR PCB LAYOUT IS ± 0.05

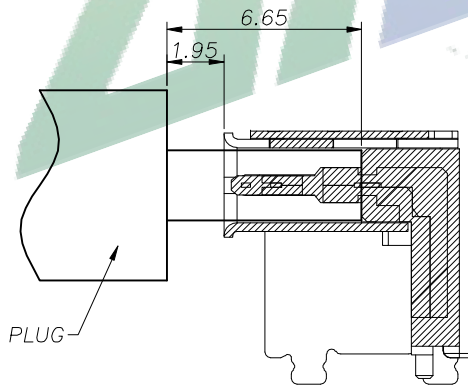

AFTER MATING
SCALE 1:1

ZHENDUAN 振端精密科技 (深圳) 有限公司
Zhenduan precision technology (Shenzhen) Co., Ltd

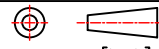
TOLERANCE: X.XX ±0.30 X.XXX ±0.20 X.XXX ±0.10 X.X ±0.10 X.X ±0.05	DRAWN BY : 刘志强	DATE : 2015.08.18	PART NAME: TYPE-C16P四脚插板加高4.3-5.9	
 UNIT: mm [inch] SCALE: 1:1 SIZE: A4	CHECKED BY: 李文毅	DATE : 2015.08.18	PART NO.	SEE TABLE
	APPROVED BY: 张少辉	DATE : 2015.08.18	MOLD NO.	
			DRAW NO:	ZDJNKJ00001627
			SHEET NO.	1 OF 1

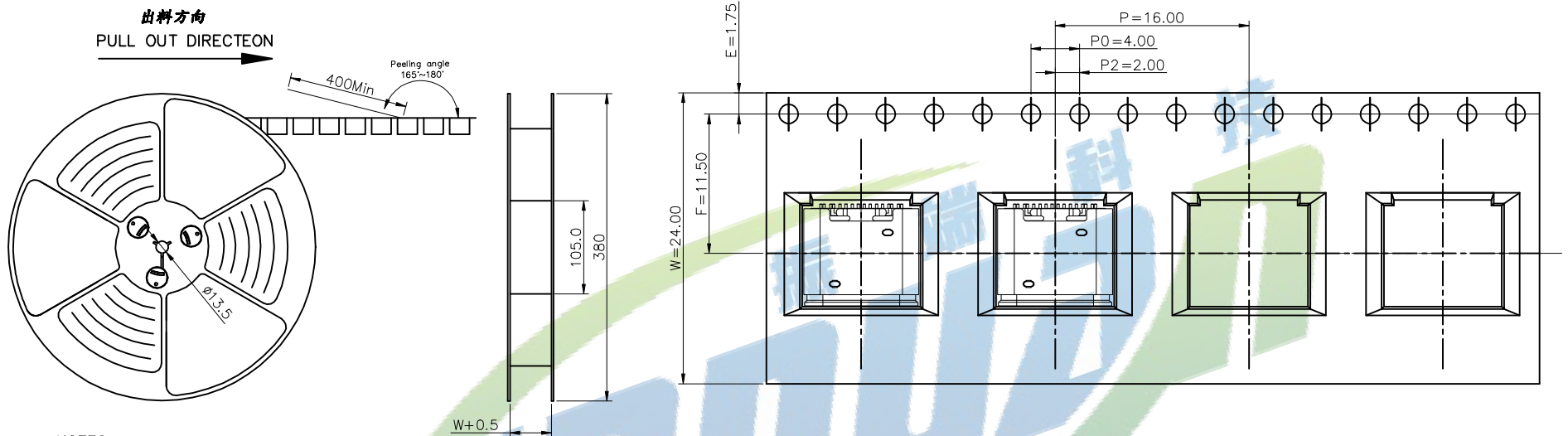

NOTES

1. 帶子引導長度
LEAD TAPE LENGTH

出料方向
PULL OUT DIRECTEON



2. 上帶剝力為：0.1~1.3N(10.2gf~130gf)

PEELING OFF FORCE OF TOP TAPE:0.1~1.3N(10.2gf~130gf)

出貨運輸過程中一定注意：

THIS REQUIREMENT SHOULD BE APPLIED AT SHIPMENT：

卷帶在運輸過程中不能裁開

PEELING OFF SHOULD NOT BE ALLOWED DURING TRANSPORTATION

TAPE & REEL 7 PCS

1 REEL
= 600 PCS

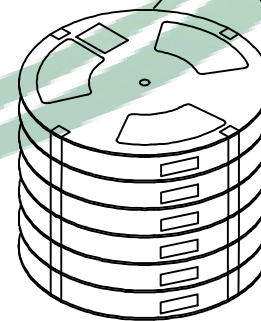

BOX

DIMENSIONS:
39.5X39.5X20

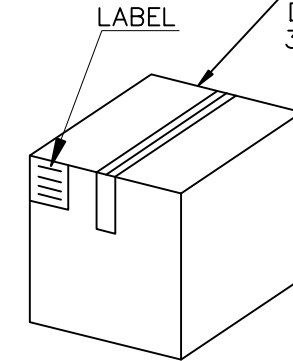

1 CARTON
=7 REELS
=4200 PCS

振端精密科技（深圳）有限公司 Zhenduan precision technology (Shenzhen) Co., Ltd			
TOLERANCE: X.X ±0.30 X.XX ±0.20 X.XXX ±0.10 X.XX ±0.10 X.X ±0.05 X ±0.05	DRAWN BY : 刘志强	DATE : 2015.08.18	PART NAME: TYPE-C16P四脚插板加高4.3-5.9
UNIT: mm [inch] SCALE:1:1 SIZE: A4	CHECKED BY: 李文毅	DATE : 2015.08.18	PART NO. SEE TABLE MOLD NO.
	APPROVED BY: 张少辉	DATE : 2015.08.18	DRAW NO.: ZDJNKJ00001627 SHEET NO. 1 OF 1