

特性:

一、电气性能: ELECTRICAL

1. 额定电流: 5.0A
2. 接触阻抗: 40 MILLIOHMS MAX
3. 耐电压: 100V AC / 1 mA MAX
4. 绝缘阻抗: 150V DC/100 MEGA OHMS MIN

二、机械性能:

1. 插入力: 5~20N ; 拔出力: 8~20N
2. 使用寿命: 10000次

三、材料: MATERIAL

四、电镀: FINISH

1. 端子: 接触点镀金1u"MIN
PIN脚焊接区域镀金G/F
2. 外壳: 镀镍80u"MIN

- 五、电镀品需做粘锡测试: 粘锡面积达到95%以上。
- 六、SMT回流焊(峰值 $260^{\circ}\text{C} \pm 5^{\circ}\text{C}$)不能起泡、熔胶、变色不良(变形在公差范围以内)
- 七、工作温度: $-55^{\circ}\text{C} \sim +85^{\circ}\text{C}$
- 八、盐雾测试: 通过48H在浓度为 $5 \pm 1\%$ 盐水的盐雾测试无生锈现象

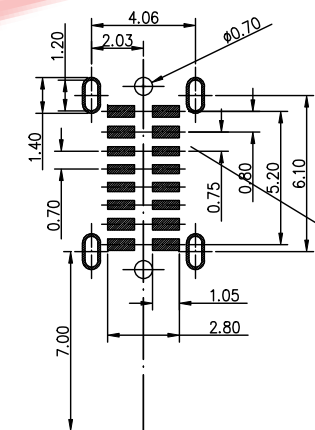
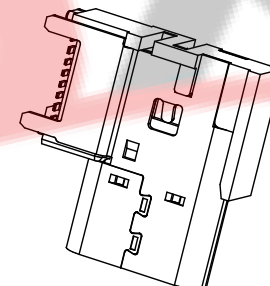
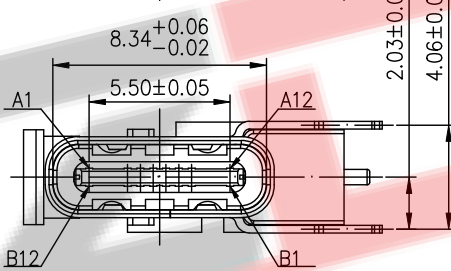

A1	GND	B12	GND
A2		B11	
A3		B10	
A4	VBUS	B9	VBUS
A5	CC1	B8	SBU2
A6	D+	B7	D-
A7	D-	B6	D+
A8	SBU1	B5	CC2
A9	VBUS	B4	VBUS
A10		B3	
A11		B2	
A12	GND	B1	GND

B12	A1
B9	A4
B8	A5
B7	A6
B6	A7
B5	A8
B4	A9
B1	A12

BOM

序号	名称	料号	用量	品名规格
1	外壳	TC01005	1	Type:侧贴16PIN 4.58外壳 SUS304 T=0.30mm
2	Molding 3	TC03011	1	Type:侧贴 SMT 16PIN Molding C7025 LCP黑色 H=4.58 半成品
2.1	Molding 1	TC03007	1	Type:侧贴 SMT 16PIN Molding A C7025 LCP黑色 H=4.58
2.2	Molding 2	TC03009	1	Type:侧贴 SMT 16PIN Molding B C7025 LCP黑色 H=4.58
2.3	卡勾	TC02016	1	Type:侧贴 SMT 16PIN 卡勾 SUS301 T=0.15mm

ZDX 深圳市兆达鑫科技有限公司
Shenzhen Zhao Xin Technology Co., Ltd.

TOLERANCE: X:XX ±0.30 X:XXX ±0.20 X:XXX ±0.10 X:XX ±0.05 X:XX ±0.02 X:XX ±0.01	DRAWN BY:	DATE:	PART NAME:	
	刘志强	2015.08.18	TYPE-C16P侧贴垫高7.20MM	
UNIT: mm [inch] SCALE: 1:1 SIZE: A4	CHECKED BY:	DATE:	PART NO.	SEE TABLE
	李毅	2015.08.18	MOLD NO.	
APPROVED BY: 张少辉	DATE:	DRAW NO.:	ZDJNK100001618	
	2015.08.18	SHEET NO.:	1 OF 1	

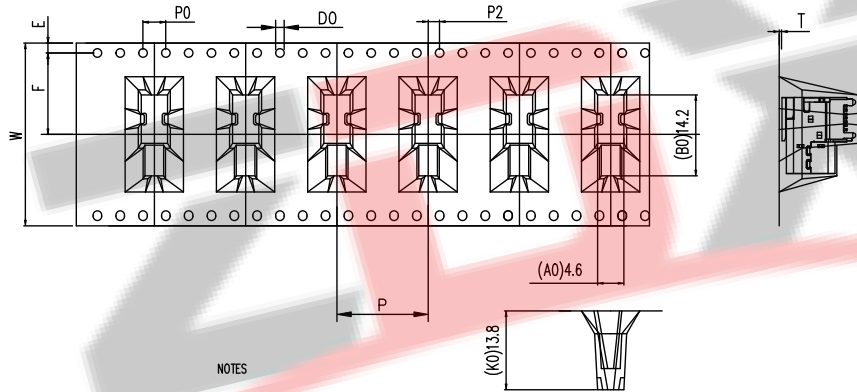
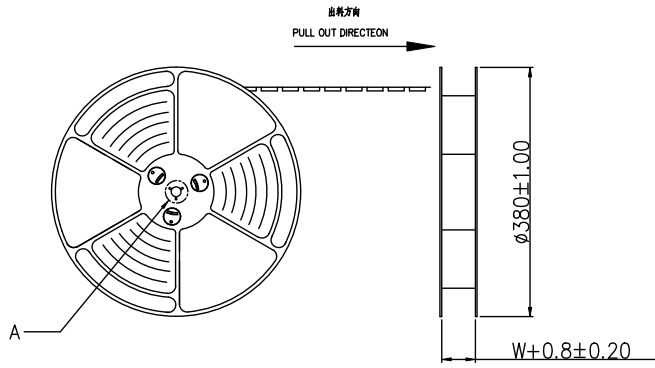

NOTES
1. 引带长度
LEAD TAPE LENGTH
出料方向
PULL OUT DIRECTEON

2. 上 力: $0.1 \sim 1.3N$ ($10.2gf \sim 130gf$)
PEELING OFF FORCE OF TOP TAPE: $0.1 \sim 1.3N$ ($10.2gf \sim 130gf$)
出料过程中注意:
THIS REQUIREMENT SHOULD BE APPLIED AT SHIPMENT:
卷在 卷中不能散
PEELING OFF SHOULD NOT BE ALLOWED DURING TRANSPORTATION

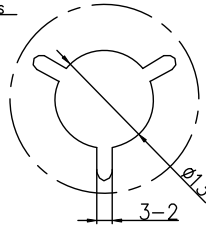
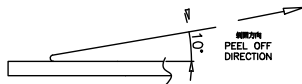

DETAIL: A
10:1

W	32±0.3
F	14.2±0.1
S0	±0.1
T	0.50±0.1
E	1.75±0.1
P	16.0±0.1
P0	4±0.1
P2	2±0.15
A0	4.60±0.1
B0	14.2±0.1
K0	13.8±0.1
D0	1.50 $\begin{matrix} +0.1 \\ -0.1 \end{matrix}$

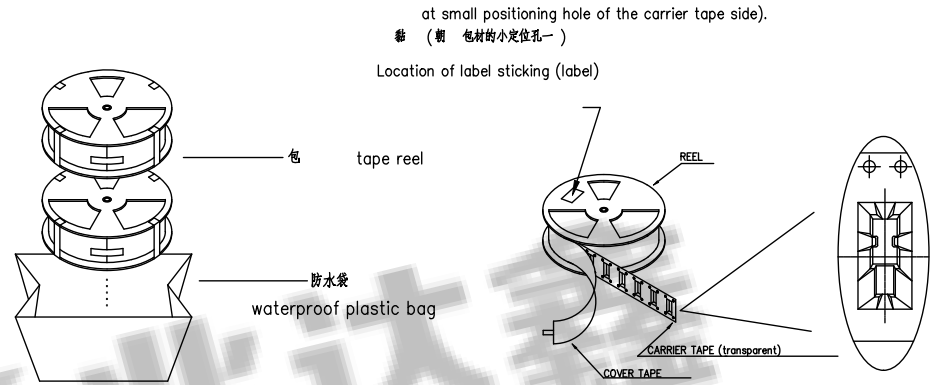

NOTE:
1. 每包量及每箱量如左下表
Packing q'ty of each reel & carton as below table shown.
2. 包的卷放入箱并以封口
Put reels in the carton and use adhesive tape to seal up.

卷带	规格: $\phi 380mm$	包装数量: 400PCS
纸箱	规格: $390mm \times 390mm \times 310mm$	包装数量: 8盘 / 3200PCS

ZDX 深圳市兆达鑫科技有限公司
Shenzhen Zhao Xin Technology Co., Ltd.

TOLERANCE: X X ±0.30 X XX ±0.20 X XXX ±0.10 X . ±10° X . ±5°	DRAWN BY : 刘志强	DATE : 2015.08.18	PART NAME: TYPE-C16P侧贴垫高7.20MM
UNIT: mm [inch] SCALE: 1:1 SIZE: A4	CHECKED BY: 李毅	DATE : 2015.08.18	PART NO. SEE TABLE
	APPROVED BY: 张少辉	DATE : 2015.08.18	MOLD NO.
			DRAW NO: ZDJNK100001618
			SHEET NO. 1 OF 1